

Product Data Sheet

Actuator 01NS120

01NS120 is a quiet and powerful actuator, which can push up to 12,000N. It's designed for use in a variety of medical and home care applications, such as patient hoist and medical bed.



Features

- Main applications: Homecare, medical
- Input voltage: 24V DC
- Max. load: 12,000N (push) / 6,000N (pull)
- Typical speed at no load: 6.9 mm/sec
- Typical speed at full load: 5.2 mm/sec (12,000N load)
- Stroke: 100 ~ 400 mm
- Noise level: ≤ 50 dB
- IP Level: IPX4
- Safety nut (in push direction)
- Preset limit switches
- Aluminum outer tube
- Stainless extension tube
- Color: Light gray RAL 7035
- Duty cycle: 10%, max. 2 min. continuous operation in 20 min.
- Ambient operation temperature: +5°C ~ +40°C
- Certified: CE Marking, MDD Directive 93/42/EEC

Options

- Mechanical push only extension tube
- Electrical push only function
- IPX6 level
- MR3 manual release: To retract actuator slowly and put down the patient safely by turning the MR3 knob with hand when losing power in the application of patient hoist (Fig. 1)
- Pivot orientation 90° turned for rear connector



Fig. 1

Performance Data

Model No.	*Push Max. (N)	Pull Max. (N)	**Typical speed (mm/s)		**Typical current (A) @ 24V	
			No load	Full load	No load	Full load
01NS120-24E8	12,000	6,000	6.3	4.4	0.6	6.6
01NS120-24F8	12,000	6,000	6.9	5.2	0.9	7.5

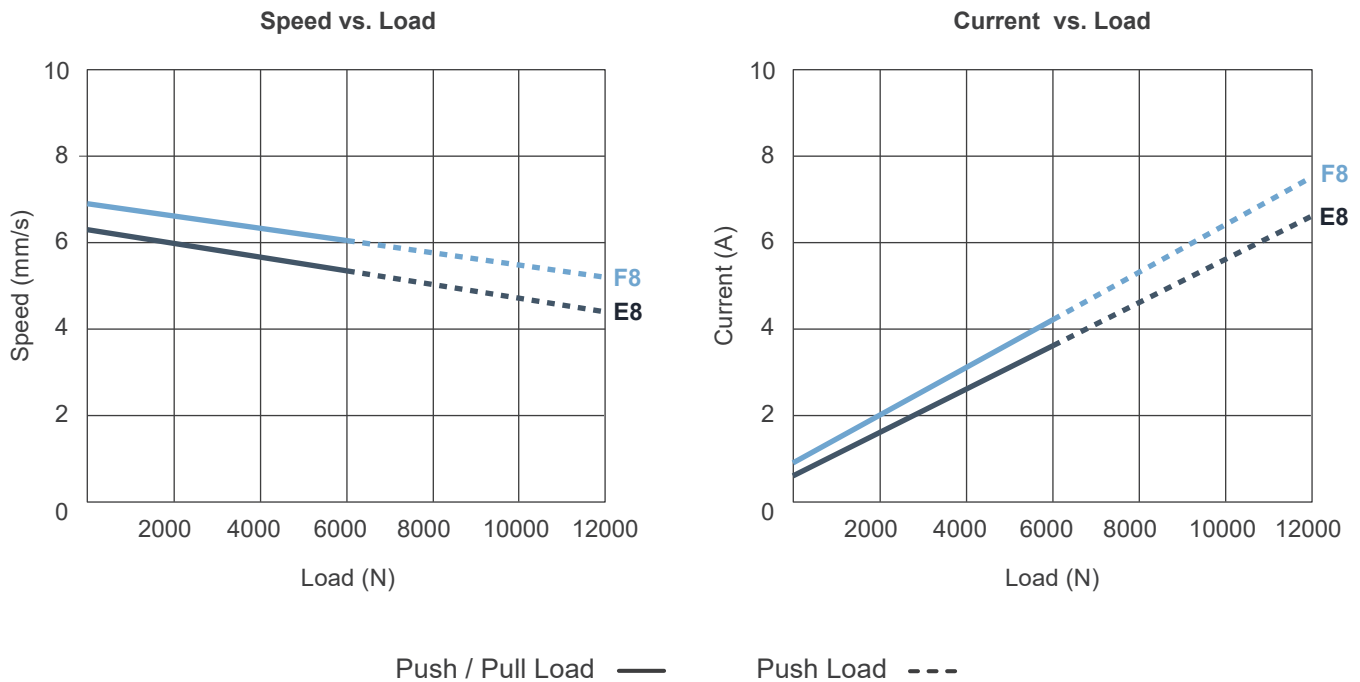

Remarks:

- * Within the stroke range of 200mm (Refer to Table 1). And max. push load is 10,000N only if MR3 with mechanical push-only option is selected.

Table 1 Maximum push load VS. stroke

Spec of stroke (mm)	At actual stroke position (mm)			
	100	200	300	400
100	12,000	-	-	-
200	12,000	12,000	-	-
300	12,000	12,000	8,000	-
400	12,000	12,000	9,000	6,000

Unit: N

- ** The typical speed or typical current means the average value neither upper limit nor lower limit. The performance curves are made with typical values.

Dimensions

Standard (without manual release)

Unit: mm

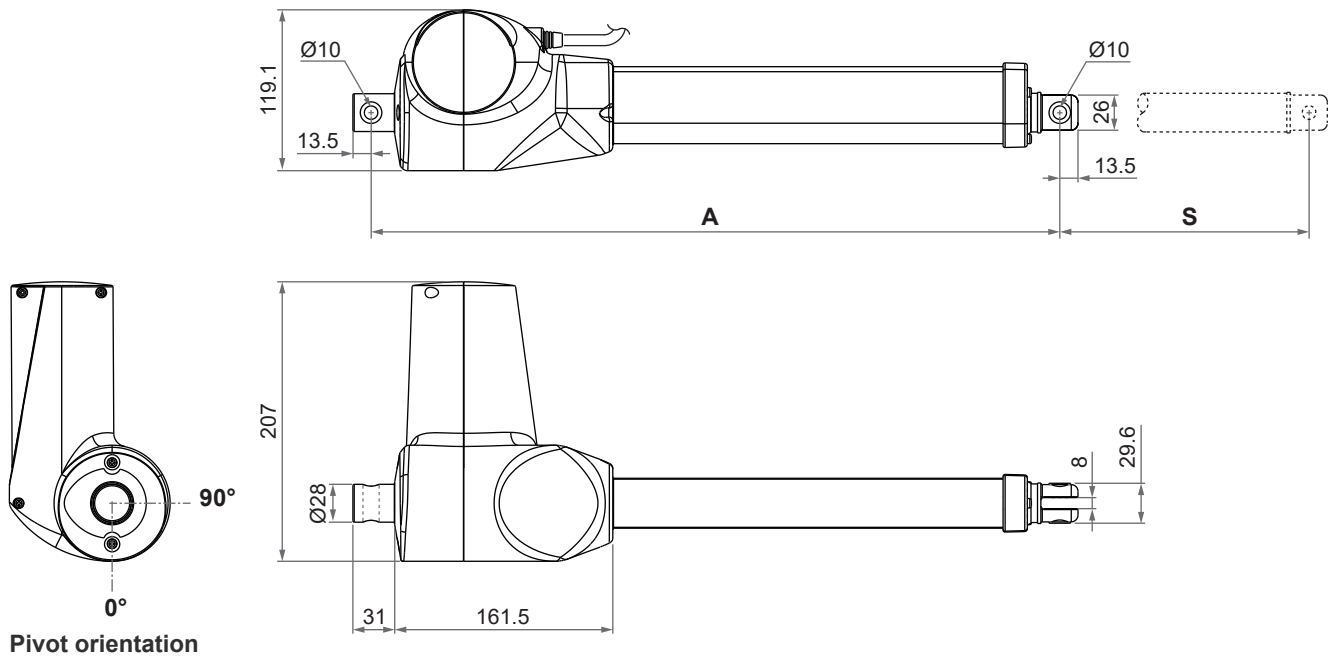

With MR3 manual release

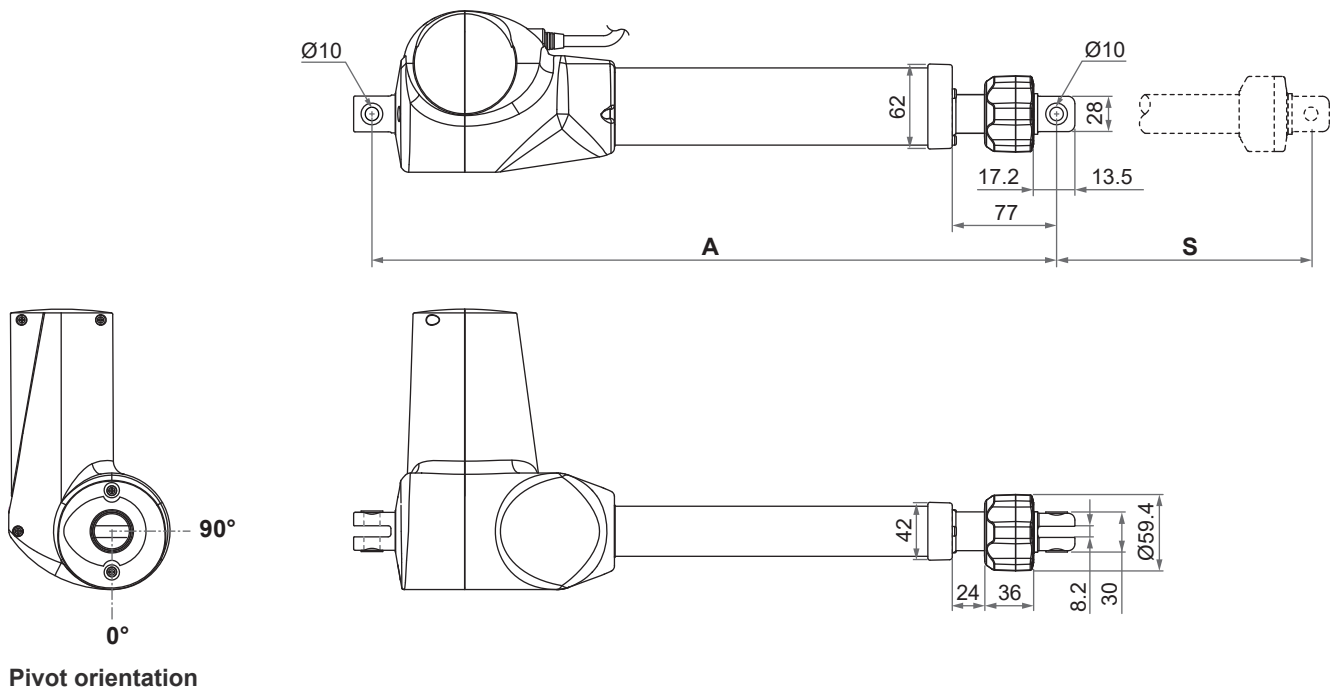

Installation Dimension

Stroke range (S)	Min. Retracted length (A)	
	Standard	With MR3 manual release
$100 \leq S \leq 300$ mm	$A \geq S + 230 (\pm 3\text{mm})$	$A \geq S + 267 (\pm 3\text{mm})$
$300 < S \leq 400$ mm	$A \geq S + 250 (\pm 3\text{mm})$	$A \geq S + 287 (\pm 3\text{mm})$

Available stroke (S) range = 100 ~ 400 mm

Extended length = S + A

Front Connector

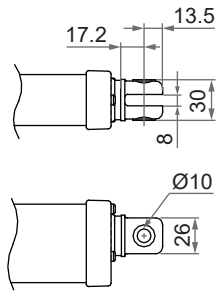

Slot type Zinc alloy (For Push load only)
 1: Slot with bushing, Ø10mm
 2: Slot w/o bushing, Ø12mm

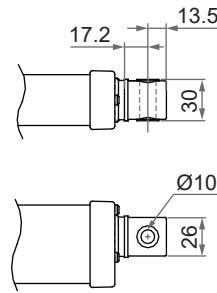

Solid type Zinc alloy
 3: Solid with bushing, Ø10mm
 4: Solid w/o bushing, Ø12mm

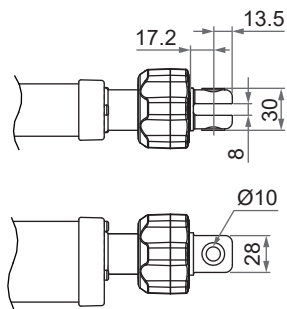

Slot type Zinc alloy with MR3 (For Push load only)
 5: Slot with bushing, Ø10mm
 6: Slot w/o bushing, Ø12mm

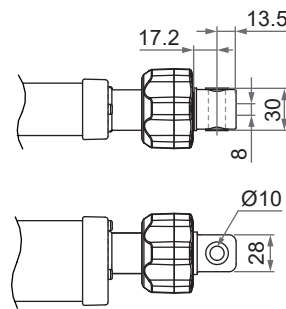

Solid type Zinc alloy with MR3 (For Push load only)
 7: Solid with bushing, Ø10mm
 8: Solid w/o bushing, Ø12mm

Rear Connector

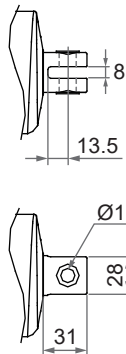

Slot type Zinc alloy, 0° pivot
 1: Slot with bushing, Ø10mm
 2: Slot w/o bushing, Ø12mm

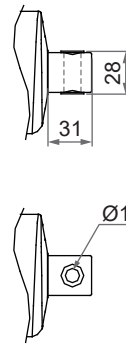

Solid type Zinc alloy, 0° pivot
 3: Solid with bushing, Ø10mm
 4: Solid w/o bushing, Ø12mm

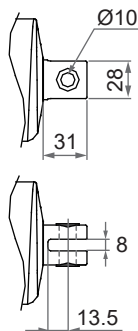

Slot type Zinc alloy, 90° pivot
 5: Slot with bushing, Ø10mm
 6: Slot w/o bushing, Ø12mm

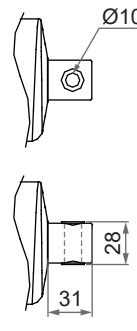

Solid type Zinc alloy, 90° pivot
 7: Solid with bushing, Ø10mm
 8: Solid w/o bushing, Ø12mm

Compatibility

Product	Model	01NS120 spec
Control box	CBP2, CBP3	With J1-type or J2-type phone jack
	CB4P-HP	With J2-type phone jack
	CM42	With J1-type phone jack

Cable Plug

J1-type phone jack

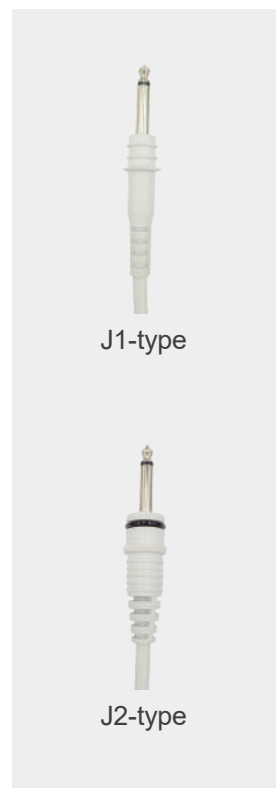
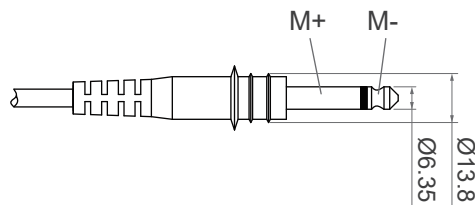

J2-type phone jack

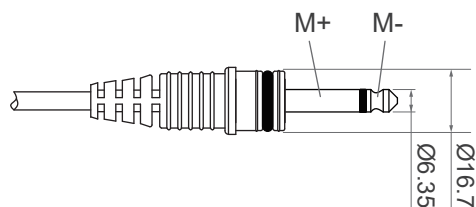

Remarks:

Connect (M+) to "+" & (M-) to "-" of DC power, the actuator will extend.

Certifications

The 01NS120 actuator is compliant with the following regulations, in terms of the essential conformity requirements of MDD Directive of 93/42/EEC.

Emission	Immunity
EN 60601-1-2:2015 CISPR11:2015 Group 1 Class B	EN 60601-1-2:2015 IEC 61000-4-2:2008 IEC 61000-4-3:2006+A1:2007+A2:2100 IEC 61000-4-8:2009

Ordering Key

01NS120 - 24 E8 - 330 . 430 - 1 1 E 0 G 4 1

Input voltage	24: 24V DC	
Motor and Spindle type	E8: 3000rpm / 8mm pitch F8: 3600rpm / 8mm pitch	
Retracted length (Refer to page 4)	XXX	
Extended length (Refer to page 4)	XXX (Please contact Moteck if the required extended length exceeds 3 digits)	
Front connector (Refer to page 5)	1: Slot with bushing, Ø10mm 2: Slot w/o bushing, Ø12mm 3: Solid with bushing, Ø10mm 4: Solid w/o bushing, Ø12mm	5: Type 1 with MR3 6: Type 2 with MR3 7: Type 3 with MR3 8: Type 4 with MR3
Rear connector (Refer to page 5)	1: Slot with bushing, Ø10mm, 0° pivot 2: Slot w/o bushing, Ø12mm, 0° pivot 3: Solid with bushing, Ø10mm, 0° pivot 4: Solid w/o bushing, Ø12mm, 0° pivot	5: Type 1 turn 90° 6: Type 2 turn 90° 7: Type 3 turn 90° 8: Type 4 turn 90°
Safety option*	0: None P: Mechanical push only extension tube E: Electrical push only function	
Reserved	0: No meaning	
Color	G: Light gray RAL 7035	
IP level	4: IPX4 (Standard) 6: IPX6	
Cable length	1: 300mm straight 2: 1000mm straight 3: 400mm coiled	