

Product Data Sheet

Actuator

610

610 features inline design which makes it an ideal product to fulfill the needs of application with limited installation space.



Features

- Main applications: Industrial automation
- Input voltage: 12V DC / 24V DC
- Max. load: 1000N (Push/Pull)
- Max. speed at no load: 18mm/sec (Typical value)
- Speed at full load: 7mm/sec (Typical value @ 1000N loaded)
- Stroke: 50 ~ 300mm
- Noise level: ≤ 65 dB
- IP level: IPX4 (Static; non-action)
- Preset limit switches
- Duty cycle: 10%, max. 2 min. continuous operation in 18 min.
- Operating ambient temperature: $-20^{\circ}\text{C} \sim +65^{\circ}\text{C}$
- Certified: CE Marking, EMC Directive 2014/30/EU

Performance Data

Model No.	Gear ratio	Push/Pull Max. (N)	Typical Speed (mm/s) *		Typical Current (A) *			
			No load	Full load	No load		Full load	
					12V	24V	12V	24V
01KS10-XX-A6-16-XXX.XXX-CXX-X	16:1	1000	10	7	4.2	3.1	5.3	3.7
01KS10-XX-A8-16-XXX.XXX-CXX-X	16:1	800	13	8	4.2	3.1	5.2	3.6
01KS10-XX-AC-16-XXX.XXX-CXX-X	16:1	500	18	12	4.2	3.1	4.9	3.4

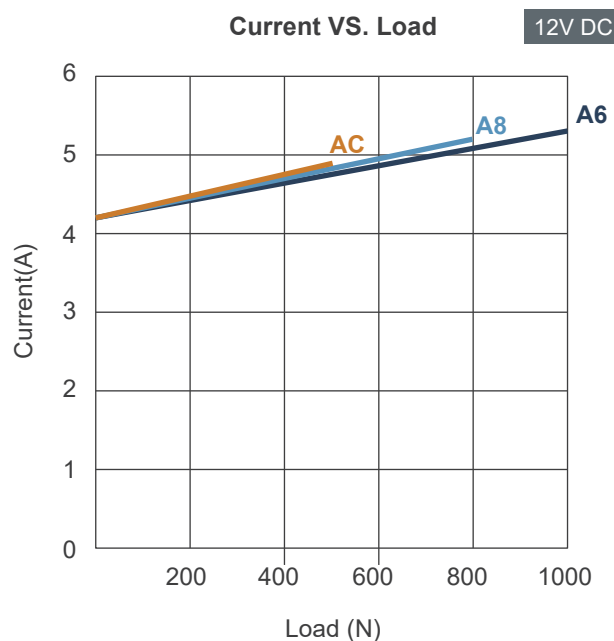
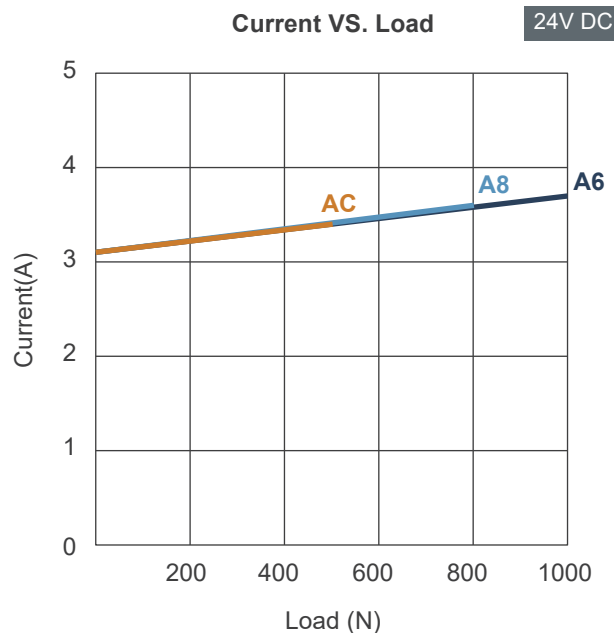
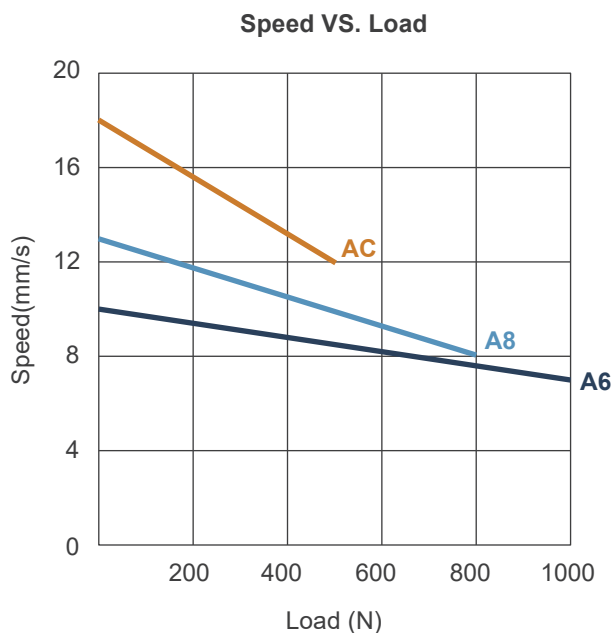

Remarks:

* The typical speed or typical current means the average value neither upper limit nor lower limit, which measured under room temperature and stable power. The performance curves are made with typical values.

Dimensions

- Available stroke (S) range = 50 ~ 300mm (±3mm)
- Extended length (B) = Retracted length (A) + Stroke (S)
- Retracted length (A)

Front connector code	Stroke (S)		
	≤ 200mm	201~250mm	251~300mm
3, 4	$A \geq S+256\text{mm} (\pm 3\text{mm})$	$A \geq S+266\text{mm} (\pm 3\text{mm})$	$A \geq S+276\text{mm} (\pm 3\text{mm})$
1, A	$A \geq S+265\text{mm} (\pm 3\text{mm})$	$A \geq S+275\text{mm} (\pm 3\text{mm})$	$A \geq S+285\text{mm} (\pm 3\text{mm})$
9	$A \geq S+282\text{mm} (\pm 3\text{mm})$	$A \geq S+292\text{mm} (\pm 3\text{mm})$	$A \geq S+302\text{mm} (\pm 3\text{mm})$

• Drawing

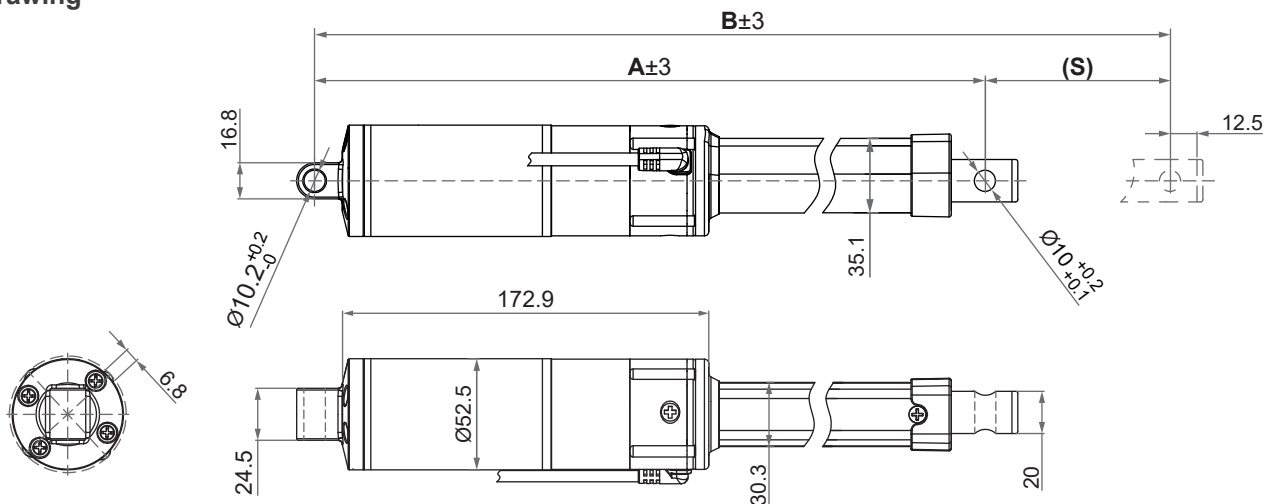

• Front connector

1: Plastic slot

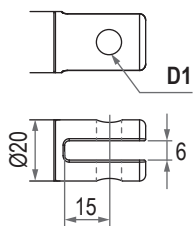

3: Drilled hole

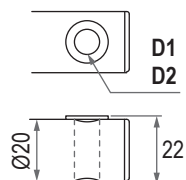

4: Plastic solid

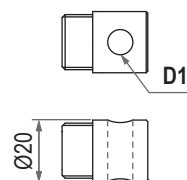

9: Spherical rod eye

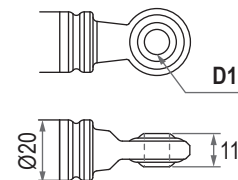

A: Metal slot

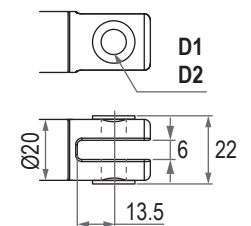

Front connector code	Diameter of pivot without bushing (D1)	Diameter of pivot with bushing (D2)
1	Ø8, Ø10	N/A
3	Ø6.4, Ø8, Ø10	Ø8
4	Ø8, Ø10	N/A
9	Ø8	N/A
A	Ø8, Ø10	Ø8

• Rear connector

6: Plastic

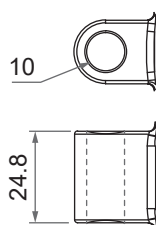

Unit: mm

Compatibility

Product	Model	01KS10 spec
Controller	CI72	Standard
Accessory	MB22 mounting bracket (Fig. 1)	Standard, mounting hole \varnothing 8mm or \varnothing 10mm



Fig. 1

Cable with Flying Leads

- Power wires

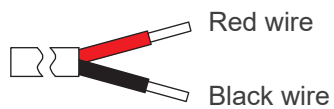

Note:

Connect red wire to "Vdc +" & black wire to "Vdc -" of DC power to extend the actuator. Switch the polarity of DC input to retract it.

Certifications

01KS10 actuator is compliant with the following regulations, in terms of the essential conformity requirements of EMC Directive of 2014/30/EU.

Emission	Immunity
EN 61000-6-3:2007+A1:2011	EN 61000-6-1:2007 IEC 61000-4-2:2008 IEC 61000-4-3:2006+A1:2007+A2:2010 IEC 61000-4-8:2009

Ordering Key

01KS10- 24 - A6 - 16 - 356 . 456 - C 3 6 - 1

Input voltage	12: 12V DC 24: 24V DC
Motor and Spindle type (Refer to Page 2)	A6: 2500rpm / 6mm pitch A8: 2500rpm / 8mm pitch AC: 2500rpm / 12mm pitch
Gear ratio	16: 16:1
Retracted length (Refer to Page 3)	XXX
Extended length (Refer to Page 3)	XXX
Front connector (Refer to Page 3)	1: Plastic slot 3: Drilled hole 4: Plastic solid 9: Spherical rod eye A: Metal slot
Rear connector (Refer to Page 3)	6: Plastic
Cable length	0: 350mm straight 1: 1000mm straight 2: 450mm with 300mm coiled