

Product Data Sheet

Actuator

660

01DS60 is a quiet and powerful actuator up to 6000N thrust, designed for use in furniture application. Our T-control box, which can be perfectly attached and integrated to FD60, is available for customers to choose.



Features and Options

Main application: Furniture

Standard features:

- Input voltage: 12V DC / 24V DC
- Max. load: 6000N (Push) / 4000N (Pull)
- Max. speed at no load: 33.3mm/sec (Typical value)
- Speed at full load: 2.9mm/sec (Typical value @6000N loaded)
- Stroke: 50 ~ 300mm
- Noise level: ≤ 50 dB
- IP level: IP42 (Static; non-action)
- Preset limit switches
- Duty cycle: 10%, max. 2 min. continuous operation in 20 min.
- Operating ambient temperature: -20°C ~ +65°C
- Certified: UL 962 Standard for Household and Commercial Furnishings
- Compliant with CE Marking, EMC Directive 2014/30/EU

Options:

- Positioning signal feedback with Hall effect sensor x 1
- Positioning signal feedback with Hall effect sensor x 2
- Mechanical push only extension tube
- Mechanical brake

Performance Data

Model No.	Push Max. (N)	Pull Max. (N)	Self-locking ability (N) *	Typical speed (mm/s) **		Typical current (A) **			
				No load	Full load	No load		Full load	
						12V	24V	12V	24V
FD60-XX-A4	6000	4000	5000	4.2	2.9	1.2	0.6	5.4	2.7
FD60-XX-A6	4000	4000	2500	6.2	3.8	1.2	0.6	5.6	2.8
FD60-XX-A8	3000	3000	2000	8.3	5.0	1.2	0.6	5.6	2.8
FD60-XX-AG	1500	1500	700	16.6	12.2	1.2	0.6	5.6	2.8
FD60-XX-KG	750	750	0	33.3	23.5	1.2	0.6	5.4	2.7
FD60-XX-F4	5000	4000	5000	5.5	4.4	1.2	0.6	5.6	2.8
FD60-XX-F8	3000	3000	2000	11.0	8.2	1.2	0.6	5.8	2.9

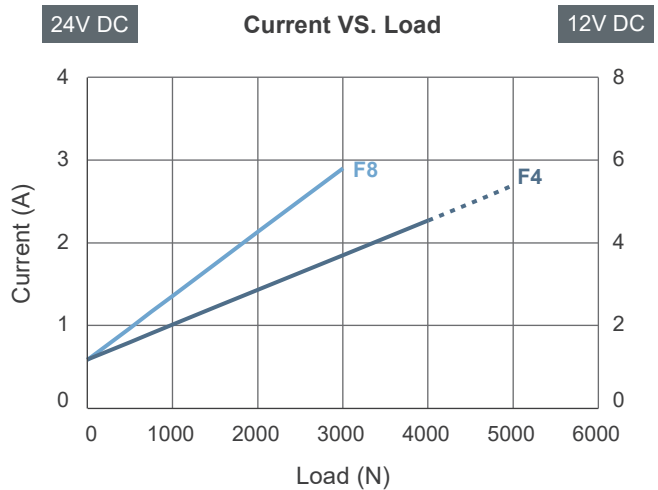
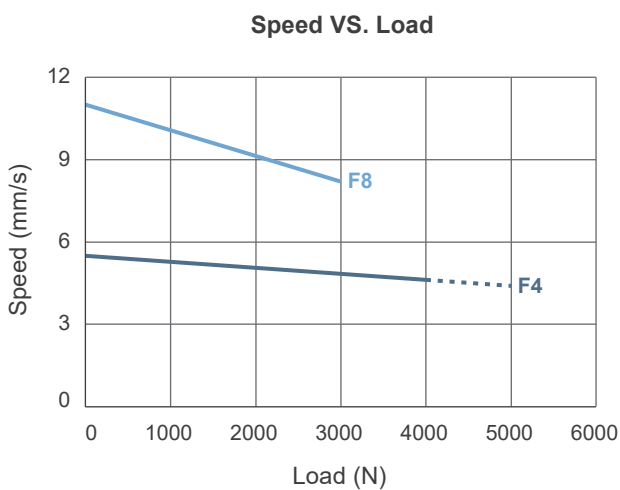
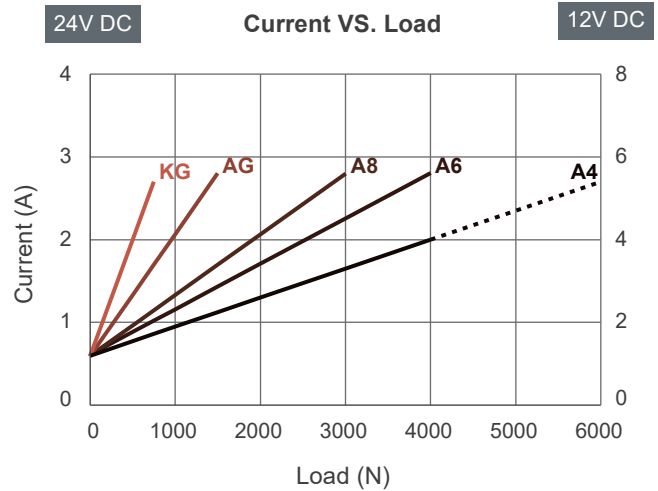
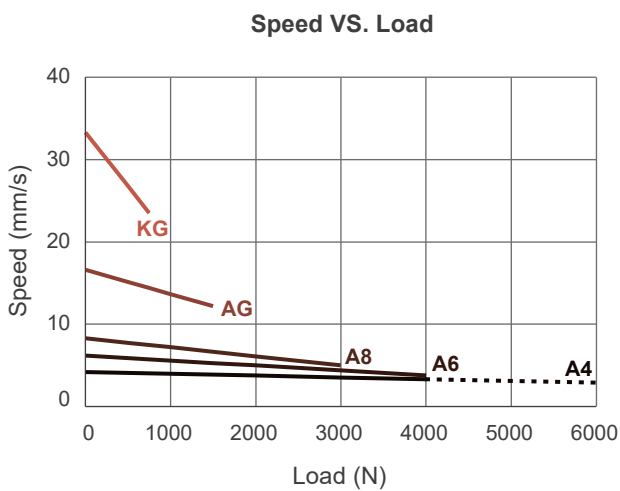

Push / Pull load — Push load - - -

Remarks:

* The self-locking ability is performed by short circuit the motor terminals when the actuator is powered off. All MOTECK compatible control boxes are designed with this feature. Mechanical brake in push direction is available upon request, to further enhance the self-locking ability to maximum load.

** The typical speed or typical current means the average value neither upper limit nor lower limit, which measured under room temperature and stable power. The performance curves are made with typical values.

Dimensions

- Available stroke (S) range = 50 ~ 300mm (±3mm)
- Extended length (B) = Retracted length (A) + Stroke (S)
- Retracted length (A)

Front connector code Rear connector code	1, 5, 8	2, 3, 7
1, 2	$A \geq S + 188\text{mm} (\pm 3\text{mm})$	$A \geq S + 160\text{mm} (\pm 3\text{mm})$
5 (with crank function)	$A \geq S + 198\text{mm} (\pm 3\text{mm})$	$A \geq S + 170\text{mm} (\pm 3\text{mm})$

• Drawing

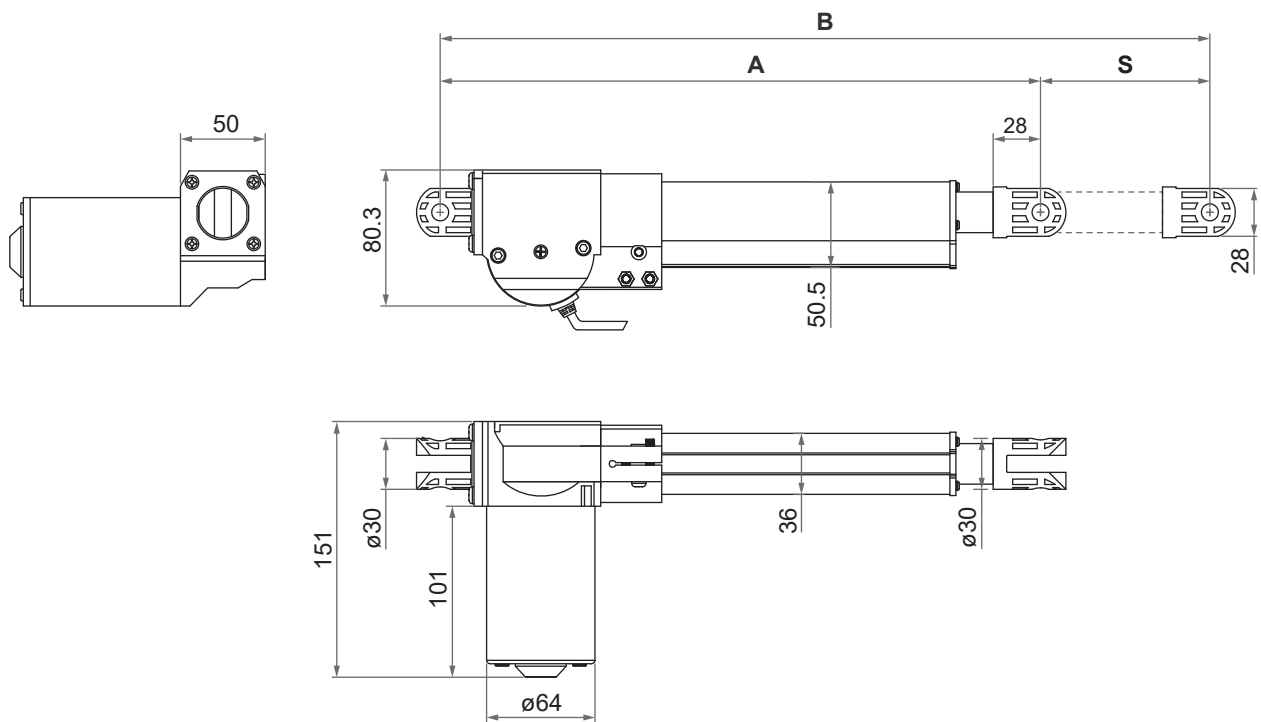

Unit: mm

● Front connector

1: Plastic

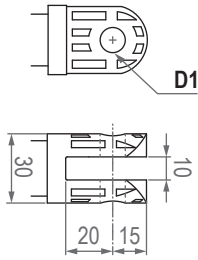

2: Brass bushing

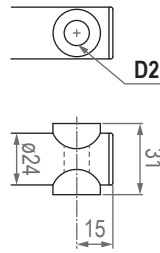

3: Drilled hole

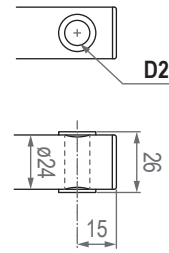

5: Metal

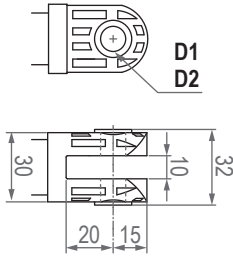

7: Plastic bushing

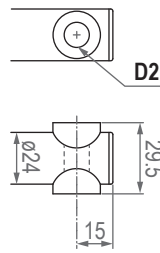

8: Enhanced metal

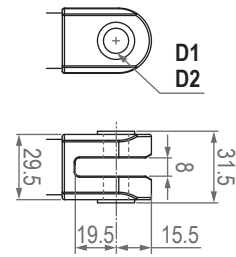

Front connector code	Diameter of pivot without bushing (D1)	Diameter of pivot with bushing (D2)
1	ø8, ø10, ø12	N/A
2	N/A	ø10
3	N/A	ø8, ø10
5	ø8, ø10, ø12	ø8, ø10
7	N/A	ø10
8	ø10, ø12	ø8, ø10

● Rear connector

1: Plastic

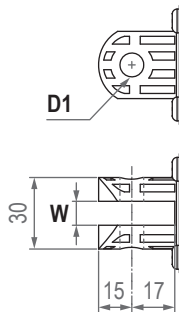

2: Metal

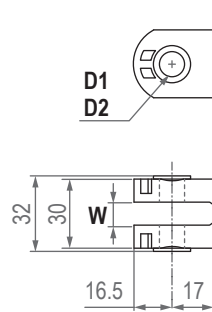

5: Metal (with crank function)

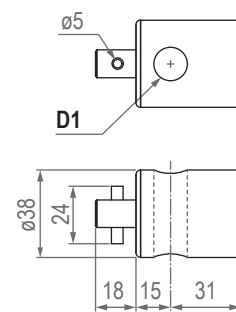

Rear connector code	Diameter of pivot without bushing (D1)	Diameter of pivot with bushing (D2)	Slot width (W)
1	ø8, ø10, ø12	N/A	6, 10
2	ø8, ø10, ø12	ø8, ø10	6, 10
5	ø14.5	N/A	N/A

Unit: mm

● **Pivot orientation of rear connectors**

0° (standard)

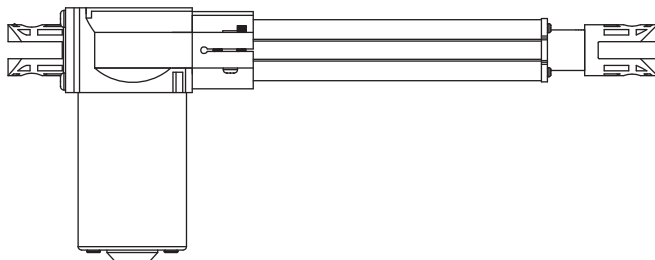
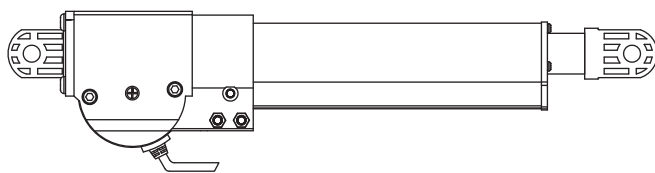

90°

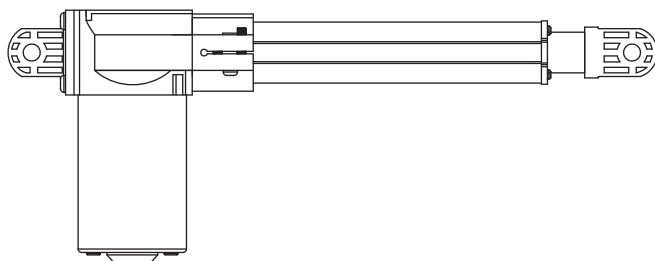
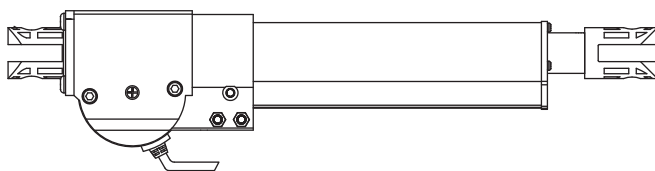

Compatibility

Product	Model	FD60 spec
Control box	T-control, CS1, CS2, CB3T, CB4M, CBT2	<ul style="list-style-type: none"> • Without positioning sensor • With Moteck F-type 4-pin DIN plug
	CF11H, CF12H	<ul style="list-style-type: none"> • Without positioning sensor • With Moteck L3-type minifit 6-pin plug
	CB3T-SY, CB4M-S, CB4M-B	<ul style="list-style-type: none"> • With dual Hall effect sensors for positioning • With Moteck F-type 6-pin DIN plug
	CB3T-SYD	<ul style="list-style-type: none"> • 12V DC motor • With dual Hall effect sensors for positioning • With Moteck F-type 6-pin DIN plug
	CF11S, CF12S	<ul style="list-style-type: none"> • With dual Hall effect sensors for positioning • With Moteck L3-type minifit 6-pin plug
	TX2A	<ul style="list-style-type: none"> • With Moteck direct-cut power cable DL1
Hand control	Depend on control box	<ul style="list-style-type: none"> • Powered by control box
	HS15	<ul style="list-style-type: none"> • With Moteck S-type DIN 41529 male plug ⁽¹⁾
	HB, TPSL, HS02, HZ02, HZ03, HZ04, HZ05, HZ06	<ul style="list-style-type: none"> • With Moteck direct-cut power cable DL1 ⁽²⁾
Accessory	Power adapter: DPA-58-2920-C8 (formerly TSW1), DPA-87-2930-C6 (formerly TSW3), WPA-29-2910-SR (formerly TSW4), DPA-87-2930-C8	<ul style="list-style-type: none"> • With Moteck direct-cut power cable DL1

Remarks:

(1) The S-type DIN 41529 plug of the actuator is connected to the HS15 hand control directly, no control box.

(2) The actuator is connected to the hand control through the DL1 cable directly, no control box.

Cable Plug

A. Connecting control devices that provide power

- Without positioning feedback

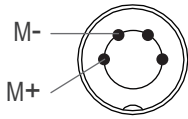

With Moetck F-type 4-pin DIN plug

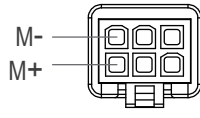

With Moetck L3-type Minifit 6-pin plug



F-type plug

- Positioning feedback with dual Hall effect sensors

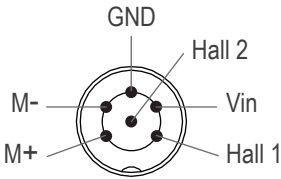

With Moetck F-type 6-pin DIN plug

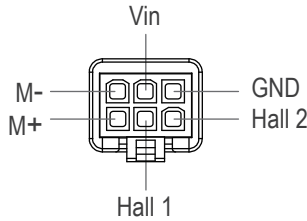

With Moetck L3-type Minifit 6-pin plug



L3-type plug

Note: Pin definition

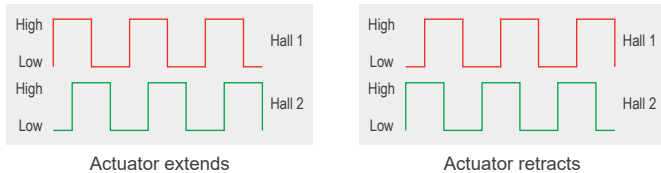
	Definition	Descriptions																
Power	M+	Connect M+ to "Vdc +" & M- to "Vdc -" of DC power to extend the actuator. Switch the polarity of DC input to retract it.																
	M-																	
Signal	Vin	Voltage input range: 5 ~ 20V																
	Hall 1 output	High= Input - 1.2V ($\pm 0.6V$) Low= GND Hall signal data: 																
	Hall 2 output	Hall effect sensor resolution: <table border="1" data-bbox="443 1601 1107 1908"> <thead> <tr> <th>Model No.</th> <th>Resolution (pulses/mm)</th> </tr> </thead> <tbody> <tr> <td>FD60-XX-A4-XXX.XXX-CXX-HSX</td> <td>10.0</td> </tr> <tr> <td>FD60-XX-F4-XXX.XXX-CXX-HSX</td> <td>10.0</td> </tr> <tr> <td>FD60-XX-A6-XXX.XXX-CXX-HSX</td> <td>6.67</td> </tr> <tr> <td>FD60-XX-A8-XXX.XXX-CXX-HSX</td> <td>5.0</td> </tr> <tr> <td>FD60-XX-F8-XXX.XXX-CXX-HSX</td> <td>5.0</td> </tr> <tr> <td>FD60-XX-AG-XXX.XXX-CXX-HSX</td> <td>2.50</td> </tr> <tr> <td>FD60-XX-KG-XXX.XXX-CXX-HSX</td> <td>1.25</td> </tr> </tbody> </table>	Model No.	Resolution (pulses/mm)	FD60-XX-A4-XXX.XXX-CXX-HSX	10.0	FD60-XX-F4-XXX.XXX-CXX-HSX	10.0	FD60-XX-A6-XXX.XXX-CXX-HSX	6.67	FD60-XX-A8-XXX.XXX-CXX-HSX	5.0	FD60-XX-F8-XXX.XXX-CXX-HSX	5.0	FD60-XX-AG-XXX.XXX-CXX-HSX	2.50	FD60-XX-KG-XXX.XXX-CXX-HSX	1.25
	Model No.	Resolution (pulses/mm)																
FD60-XX-A4-XXX.XXX-CXX-HSX	10.0																	
FD60-XX-F4-XXX.XXX-CXX-HSX	10.0																	
FD60-XX-A6-XXX.XXX-CXX-HSX	6.67																	
FD60-XX-A8-XXX.XXX-CXX-HSX	5.0																	
FD60-XX-F8-XXX.XXX-CXX-HSX	5.0																	
FD60-XX-AG-XXX.XXX-CXX-HSX	2.50																	
FD60-XX-KG-XXX.XXX-CXX-HSX	1.25																	
GND																		

B. Connecting control devices that DO NOT provide power

1. Cable solution

- With direct-cut power cable DL1

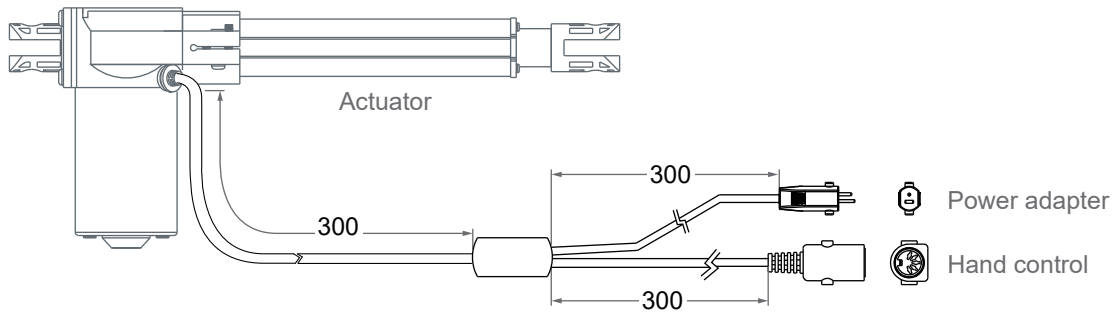

2. Hand control connector: Moteck U-type DIN 5-pin female connector

- 1 drive

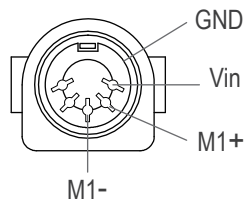

Note: Connect M1+ to "Vdc +" & M1- to "Vdc -" of DC power to extend the M1 actuator. Switch the polarity of DC input to retract it.



U-type female connector

3. Power connector: Moteck S-type DIN 41529 2-pin male plug

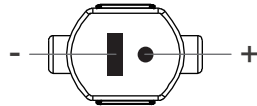

S-type male plug

Wiring with Flying Leads

- Basic, without positioning feedback.

	Wire color	Definition	Descriptions
Power wires	White	DC Power	Connect white wire to "Vdc +" & black wire to "Vdc -" of DC power to extend the actuator. Switch the polarity of DC input to retract it.
	Black		

- With single Hall effect sensor for positioning

	Wire color	Definitions	Descriptions
Power wires	Blue	DC Power	Connect blue wire to "Vdc +" & brown wire to "Vdc -" of DC power to extend the actuator. Switch the polarity of DC input to retract it.
	Brown		
Signal wires	Yellow	Vin	Voltage input range: 5 ~ 20V
	Red	Hall output	High= Input - 1.2V ($\pm 0.6V$) Low= GND Hall signal data:
			
			Hall effect sensor resolution:
Black	GND		

Model No.	Resolution (Pulses/mm)
FD60-XX-A4-XXX.XXX-CXX-HS3	10.0
FD60-XX-F4-XXX.XXX-CXX-HS3	10.0
FD60-XX-A6-XXX.XXX-CXX-HS3	6.67
FD60-XX-A8-XXX.XXX-CXX-HS3	5.0
FD60-XX-F8-XXX.XXX-CXX-HS3	5.0
FD60-XX-AG-XXX.XXX-CXX-HS3	2.50
FD60-XX-KG-XXX.XXX-CXX-HS3	1.25

• With dual Hall effect sensors for positioning

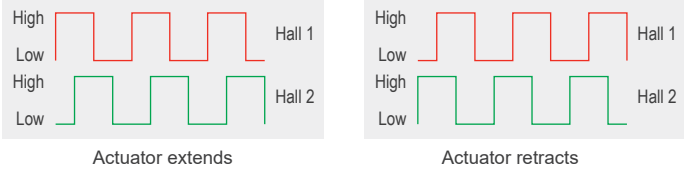
	Wire color	Definitions	Descriptions																
Power wires	Blue	DC Power	Connect blue wire to "Vdc +" & brown wire to "Vdc -" of DC power to extend the actuators. Switch the polarity of DC input to retract it.																
	Brown																		
Signal wires	Yellow	Vin	Voltage input range: 5 ~ 20V																
	Red	Hall 1 output	High= Input - 1.2V (±0.6V) Low= GND Hall signal data: 																
	Green	Hall 2 output	Hall effect sensor resolution: <table border="1" data-bbox="676 725 1409 1032"> <thead> <tr> <th>Model No.</th> <th>Resolution (Pulses/mm)</th> </tr> </thead> <tbody> <tr> <td>FD60-XX-A4-XXX.XXX-CXX-HS4</td> <td>10.0</td> </tr> <tr> <td>FD60-XX-F4-XXX.XXX-CXX-HS4</td> <td>10.0</td> </tr> <tr> <td>FD60-XX-A6-XXX.XXX-CXX-HS4</td> <td>6.67</td> </tr> <tr> <td>FD60-XX-A8-XXX.XXX-CXX-HS4</td> <td>5.0</td> </tr> <tr> <td>FD60-XX-F8-XXX.XXX-CXX-HS4</td> <td>5.0</td> </tr> <tr> <td>FD60-XX-AG-XXX.XXX-CXX-HS4</td> <td>2.50</td> </tr> <tr> <td>FD60-XX-KG-XXX.XXX-CXX-HS4</td> <td>1.25</td> </tr> </tbody> </table>	Model No.	Resolution (Pulses/mm)	FD60-XX-A4-XXX.XXX-CXX-HS4	10.0	FD60-XX-F4-XXX.XXX-CXX-HS4	10.0	FD60-XX-A6-XXX.XXX-CXX-HS4	6.67	FD60-XX-A8-XXX.XXX-CXX-HS4	5.0	FD60-XX-F8-XXX.XXX-CXX-HS4	5.0	FD60-XX-AG-XXX.XXX-CXX-HS4	2.50	FD60-XX-KG-XXX.XXX-CXX-HS4	1.25
	Model No.	Resolution (Pulses/mm)																	
FD60-XX-A4-XXX.XXX-CXX-HS4	10.0																		
FD60-XX-F4-XXX.XXX-CXX-HS4	10.0																		
FD60-XX-A6-XXX.XXX-CXX-HS4	6.67																		
FD60-XX-A8-XXX.XXX-CXX-HS4	5.0																		
FD60-XX-F8-XXX.XXX-CXX-HS4	5.0																		
FD60-XX-AG-XXX.XXX-CXX-HS4	2.50																		
FD60-XX-KG-XXX.XXX-CXX-HS4	1.25																		
Black	GND																		

Ordering Key

		FD60-	24	A4	350	470	C	1	2	HS3	PO-BK	0
Input voltage	12: 12V DC 24: 24V DC											
Motor and Spindle type	A4: 2500rpm / 4mm pitch A6: 2500rpm / 6mm pitch A8: 2500rpm / 8mm pitch AG: 2500rpm / 16mm pitch KG: 2500rpm / 16mm pitch F4: 3300rpm / 4mm pitch F8: 3300rpm / 8mm pitch											
Retracted length (Refer to Page 3)	XXX											
Extended length (Refer to Page 3)	XXX											
Front connector (Refer to Page 4)	1: Plastic 2: Brass bushing 3: Drilled hole 5: Metal 7: Plastic bushing 8: Enhanced metal											
Rear connector (Refer to Page 4)	1: Plastic 2: Metal 5: Metal (with crank function)											
Positioning feedback	Blank: None HS3: Hall effect sensor x 1 HS4: Hall effect sensor x 2											
Option (Multiple choice is allowed)	Blank: None PO: Mechanical push only extension tube BK: Mechanical brake											
Cable length	0: 300mm straight 1: 1000mm straight 2: 450mm with 300mm coiled A: Direct-cut power cable DL1 (Refer to Page 8)											